

## BSPQ Series



BSPQ Series supports miniaturized devices. Its low inductance, high precision and higher Q enables easy impedance matching at both RF and IF circuits and compact high frequency circuit designing.

### Features

- Film Type
- Excellent high frequency application
- Higher Q factor
- Miniaturization
- Tight tolerance

### Applications

- RF matching circuit requiring Q value
- Bluetooth, WLAN, UWB, digital TV tuners and high-frequency circuit and module

### Product Identification

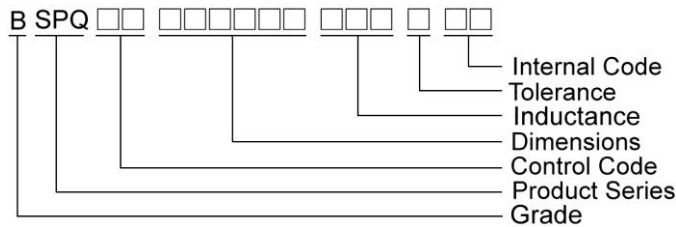

### Shape and Dimensions

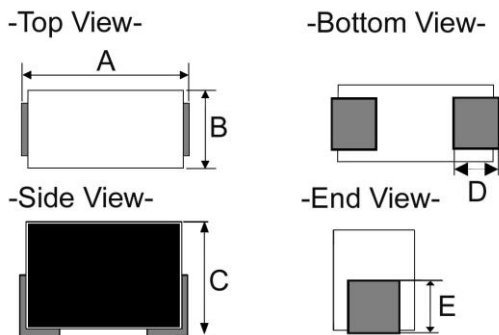

Dimensions in mm

TYPE	A	B	C	D	E
BSPQ00060304	0.6±0.03	0.3±0.03	0.4±0.03	0.15±0.03	0.2±0.03

### Recommended Pattern

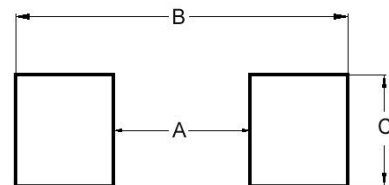

Dimensions in mm

TYPE	A	B	C
BSPQ00060304	0.3	0.75 ~ 1.05	0.3

## SMD Ceramic High Q RF Chip Inductors – BSPQ Series

### Electrical Characteristics

Part Number	Inductance (nH)	Tolerance (±%)	Q Min	Test Frequency (MHz)	SRF (MHz) Min	RDC (Ω) Max	Rated Current (mA) Max
BSPQ000603040N6□00	0.6	±0.1nH/±0.2nH	20	500	20000	0.04	1100
BSPQ000603040N7□00	0.7	±0.1nH/±0.2nH	20	500	20000	0.04	1100
BSPQ000603040N8□00	0.8	±0.1nH/±0.2nH	20	500	18000	0.04	1100
BSPQ000603040N9□00	0.9	±0.1nH/±0.2nH	20	500	18000	0.04	1100
BSPQ000603041N0□00	1.0	±0.1nH/±0.2nH	20	500	16000	0.04	1100
BSPQ000603041N1□00	1.1	±0.1nH/±0.2nH	20	500	14000	0.04	1100
BSPQ000603041N2□00	1.2	±0.1nH/±0.2nH	20	500	13000	0.04	1100
BSPQ000603041N3v00	1.3	±0.1nH/±0.2nH	20	500	13000	0.04	1100
BSPQ000603041N4□00	1.4	±0.1nH/±0.2nH	20	500	12000	0.04	1100
BSPQ000603041N5□00	1.5	±0.1nH/±0.2nH	20	500	12000	0.05	1000
BSPQ000603041N6□00	1.6	±0.1nH/±0.2nH	20	500	10000	0.05	1000
BSPQ000603041N7□00	1.7	±0.1nH/±0.2nH	20	500	10000	0.07	800
BSPQ000603041N8□00	1.8	±0.1nH/±0.2nH	20	500	10000	0.08	800
BSPQ000603041N9□00	1.9	±0.1nH/±0.2nH	20	500	10000	0.12	600
BSPQ000603042N0□00	2.0	±0.1nH/±0.2nH	20	500	9000	0.12	600
BSPQ000603042N1□00	2.1	±0.1nH/±0.2nH	20	500	9000	0.12	600
BSPQ000603042N2□00	2.2	±0.1nH/±0.2nH	20	500	9000	0.12	600
BSPQ000603042N3□00	2.3	±0.1nH/±0.2nH	20	500	9000	0.12	600
BSPQ000603042N4□00	2.4	±0.1nH/±0.2nH	20	500	9000	0.12	600
BSPQ000603042N5□00	2.5	±0.1nH/±0.2nH	20	500	9000	0.12	600
BSPQ000603042N6□00	2.6	±0.1nH/±0.2nH	20	500	9000	0.12	600
BSPQ000603042N7□00	2.7	±0.1nH/±0.2nH	20	500	9000	0.12	600
BSPQ000603042N8□00	2.8	±0.1nH/±0.2nH	20	500	8000	0.12	600
BSPQ000603042N9□00	2.9	±0.1nH/±0.2nH	20	500	8000	0.12	600
BSPQ000603043N0□00	3.0	±0.1nH/±0.2nH	20	500	8000	0.12	600
BSPQ000603043N1□00	3.1	±0.1nH/±0.2nH	20	500	7500	0.17	500
BSPQ000603043N2□00	3.2	±0.1nH/±0.2nH	20	500	7000	0.17	500
BSPQ000603043N3□00	3.3	±0.1nH/±0.2nH	20	500	7000	0.17	500
BSPQ000603043N4□00	3.4	±0.1nH/±0.2nH	20	500	7000	0.17	500
BSPQ000603043N5□00	3.5	±0.1nH/±0.2nH	20	500	7000	0.17	500
BSPQ000603043N6□00	3.6	±0.1nH/±0.2nH	20	500	7000	0.17	500
BSPQ000603043N7□00	3.7	±0.1nH/±0.2nH	20	500	7000	0.17	500

**Note: When ordering, please specify tolerance code. Tolerance : B=±0.1nH , C=±0.2nH , H=±3% , J=±5%**

- Operating temperature range - 55°C ~ 125°C(Including self - temperature rise)
- Rated Current : Applied the current to coils, the temperature rise shall not be more than 25°C
- Residual impedance of short chip : 0.48nH
- Measure Equipment :  
 L & Q : Agilent E4991A+Agilent 16197A (or equivalent)  
 SRF : Agilent E4991A or HP19196C  
 RDC : HP4338B or CHEN HWA 502

# SMD Ceramic High Q RF Chip Inductors – BSPQ Series

## Electrical Characteristics

Part Number	Inductance (nH)	Tolerance (±%)	Q Min	Test Frequency (MHz)	SRF (MHz) Min	RDC (Ω) Max	Rated Current (mA) Max
BSPQ000603043N8□00	3.8	±0.1nH/±0.2nH	20	500	7000	0.17	500
BSPQ000603043N9□00	3.9	±0.1nH/±0.2nH	20	500	7000	0.17	500
BSPQ000603044N0□00	4.0	±0.1nH/±0.2nH	20	500	7000	0.17	500
BSPQ000603044N1□00	4.1	±0.1nH/±0.2nH	20	500	7000	0.17	500
BSPQ000603044N2□00	4.2	±0.1nH/±0.2nH	20	500	7000	0.17	500
BSPQ000603044N3□00	4.3	3/5	20	500	7000	0.17	500
BSPQ000603044N7□00	4.7	3/5	20	500	7000	0.25	400
BSPQ000603045N1□00	5.1	3/5	20	500	5500	0.25	400
BSPQ000603045N6□00	5.6	3/5	20	500	5500	0.25	400
BSPQ000603046N2□00	6.2	3/5	20	500	5500	0.25	400
BSPQ000603046N8□00	6.8	3/5	20	500	5500	0.30	400
BSPQ000603047N5□00	7.5	3/5	20	500	4500	0.30	400
BSPQ000603048N2□00	8.2	3/5	20	500	4500	0.40	300
BSPQ000603049N1□00	9.1	3/5	20	500	4500	0.40	300
BSPQ0006030410N□00	10	3/5	20	500	4500	0.40	300
BSPQ0006030412N□00	12	3/5	20	500	4000	0.50	300
BSPQ0006030415N□00	15	3/5	20	500	3500	0.70	300
BSPQ0006030418N□00	18	3/5	20	500	3500	0.80	250
BSPQ0006030422N□00	22	3/5	20	500	3000	0.82	250

**Note:** When ordering, please specify tolerance code. Tolerance : B=±0.1nH , C=±0.2nH , H=±3% , J=±5%

- Operating temperature range - 55°C ~ 125°C(Including self - temperature rise)
- Rated Current : Applied the current to coils, the temperature rise shall not be more than 25°C
- Residual impedance of short chip : 0.48nH
- Measure Equipment :  
 L & Q : Agilent E4991A+Agilent 16197A (or equivalent)  
 SRF : Agilent E4991A or HP19196C  
 RDC : HP4338B or CHEN HWA 502

## Test Instruments : Agilent E4991A Material/Impedance Analyzer

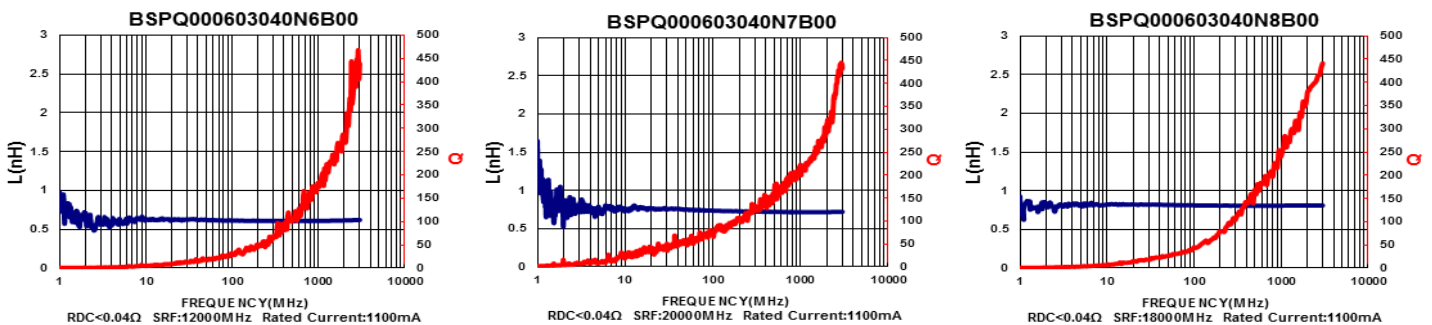

Please be sure to request approval specifications that provide further details of the products. Kindly note that the content of these specifications are subject to change or may be discontinued without prior notice. This product may not be designed/used in medical or high risk applications without Chilisin approval. Please contact our sales department before ordering.

# SMD Ceramic High Q RF Chip Inductors – BSPQ Series

Test Instruments : Agilent E4991A Material/Impedance Analyzer

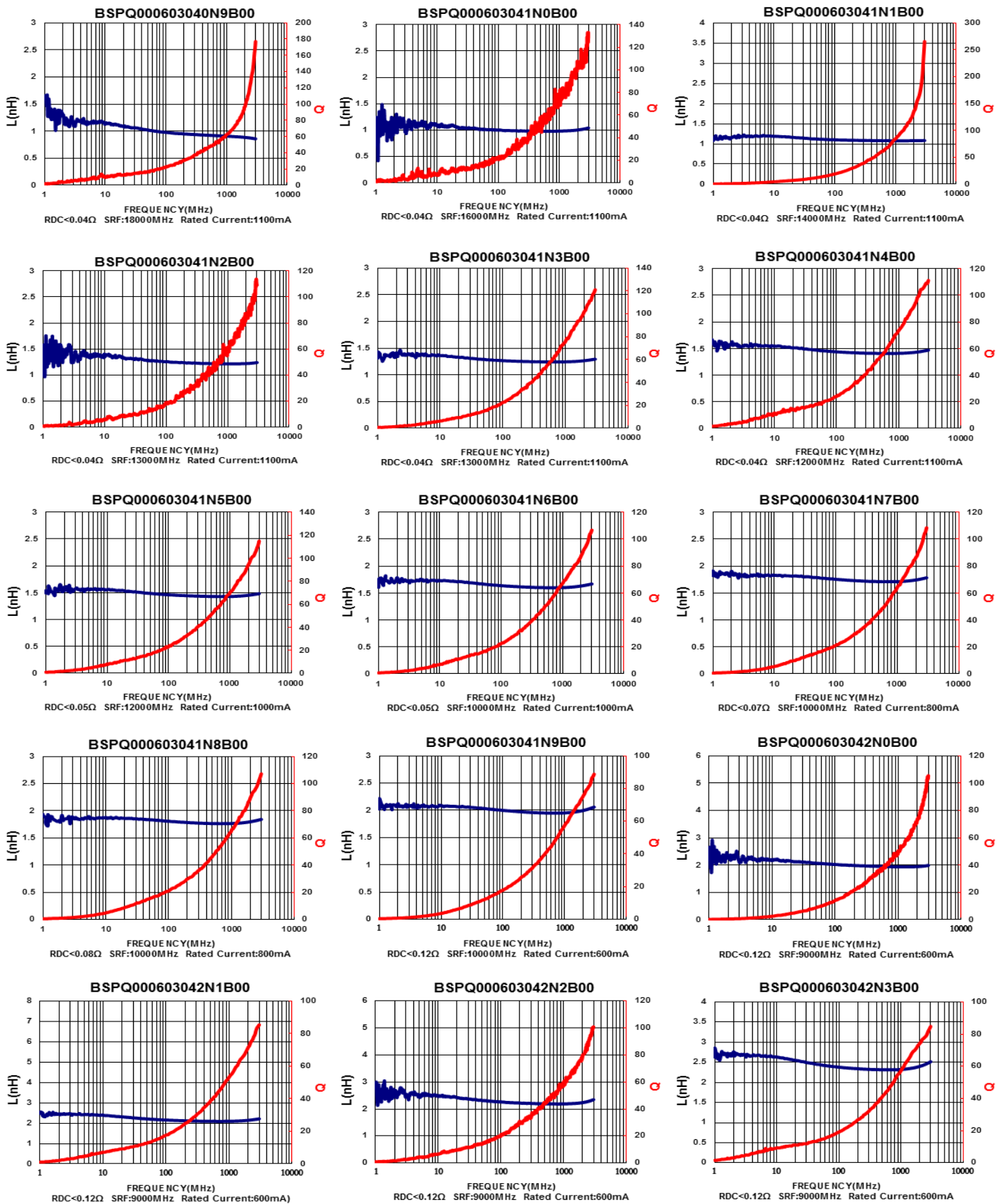

Please be sure to request approval specifications that provide further details of the products. Kindly note that the content of these specifications are subject to change or may be discontinued without prior notice. This product may not be designed/used in medical or high risk applications without Chilisin approval. Please contact our sales department before ordering.

# SMD Ceramic High Q RF Chip Inductors – BSPQ Series

Test Instruments : Agilent E4991A Material/Impedance Analyzer

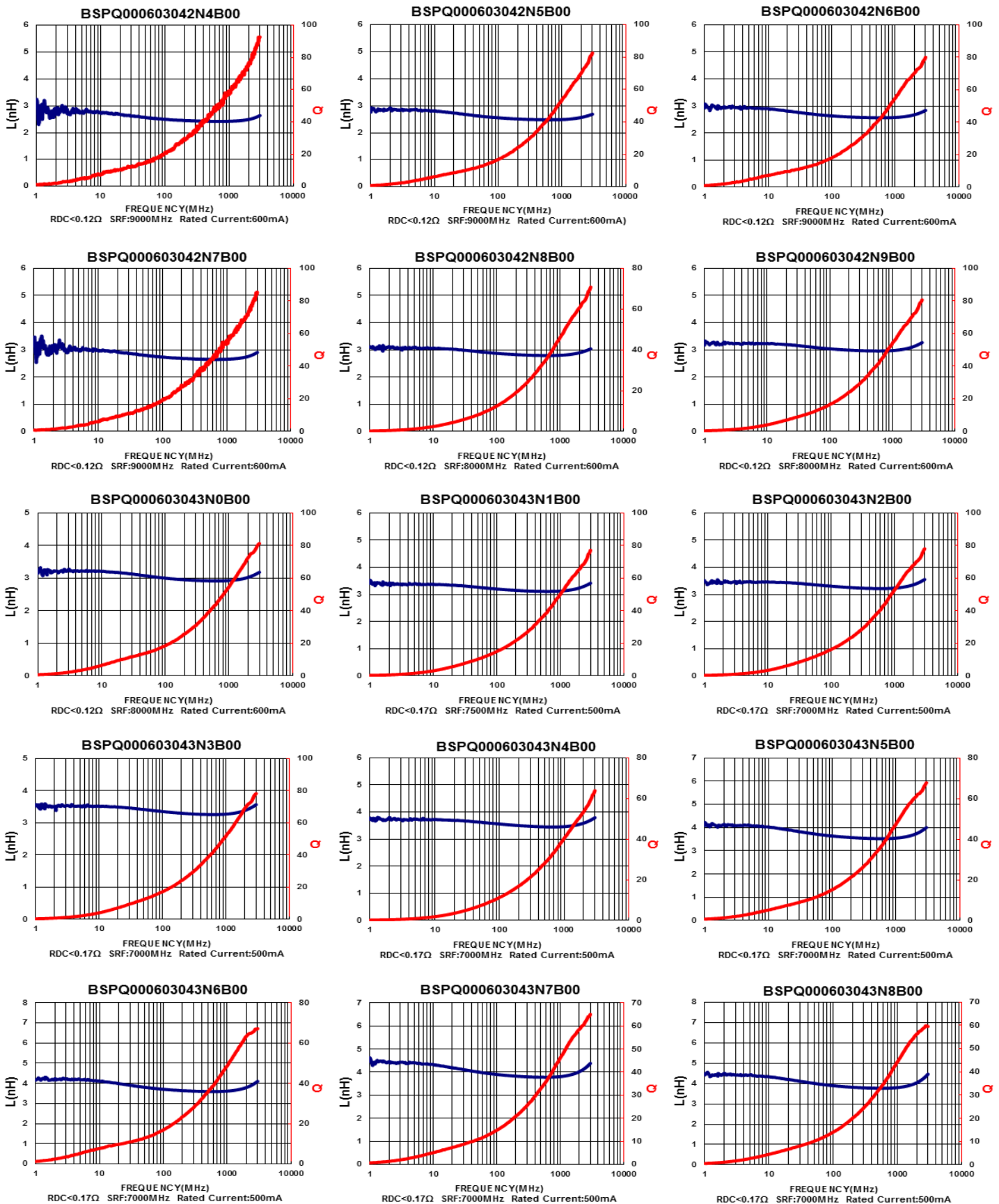

Please be sure to request approval specifications that provide further details of the products. Kindly note that the content of these specifications are subject to change or may be discontinued without prior notice. This product may not be designed/used in medical or high risk applications without Chilisin approval. Please contact our sales department before ordering.

# SMD Ceramic High Q RF Chip Inductors – BSPQ Series

Test Instruments : Agilent E4991A Material/Impedance Analyzer

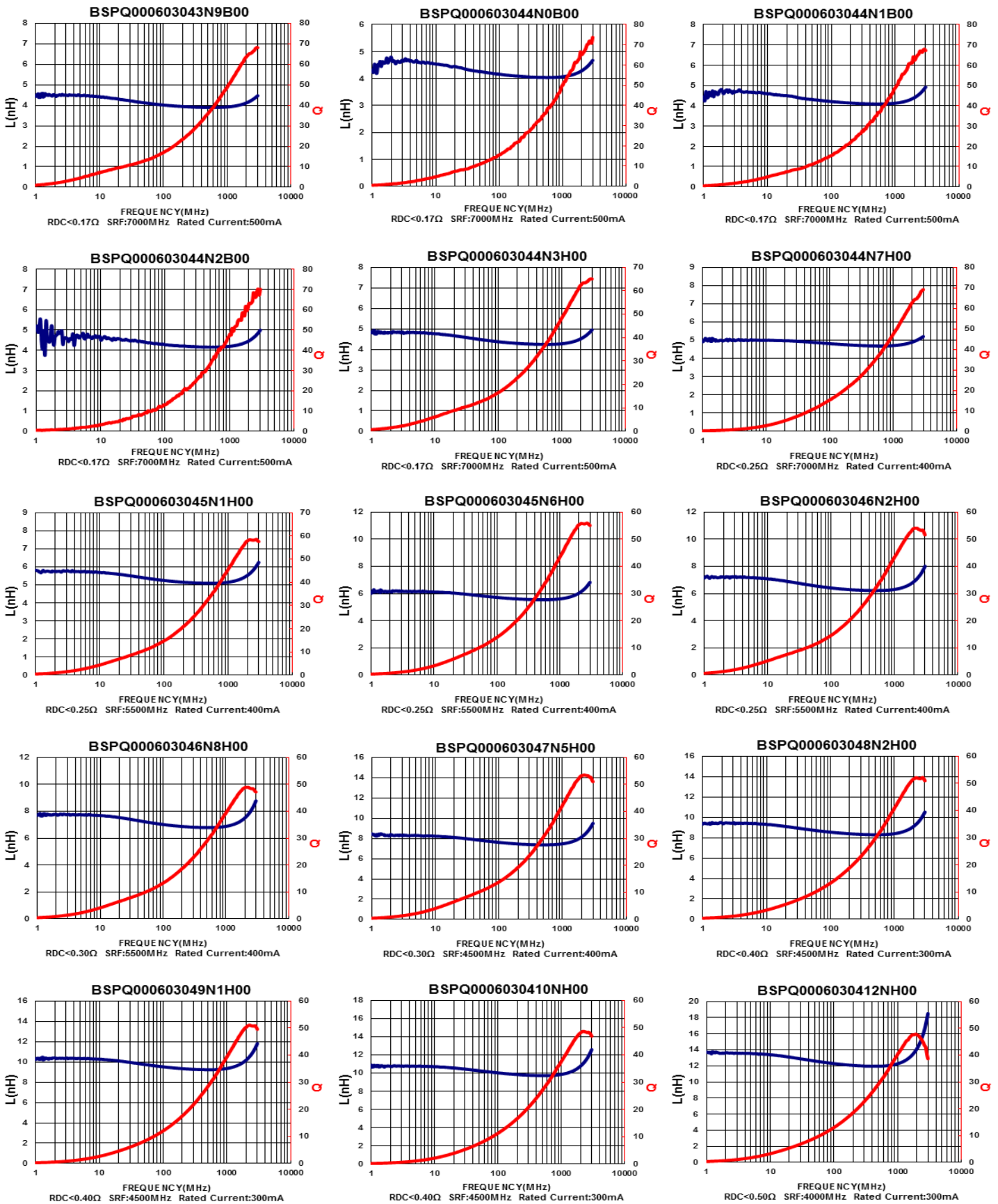

Please be sure to request approval specifications that provide further details of the products. Kindly note that the content of these specifications are subject to change or may be discontinued without prior notice. This product may not be designed/used in medical or high risk applications without Chilisin approval. Please contact our sales department before ordering.

# SMD Ceramic High Q RF Chip Inductors – BSPQ Series

Test Instruments : Agilent E4991A Material/Impedance Analyzer

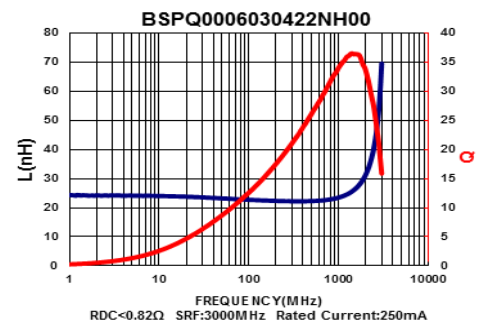
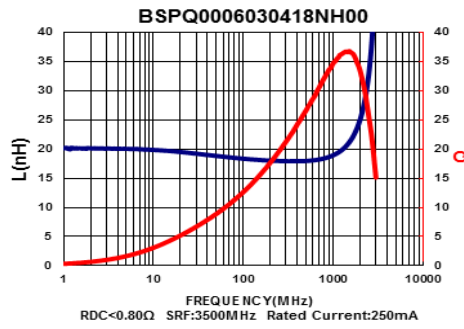
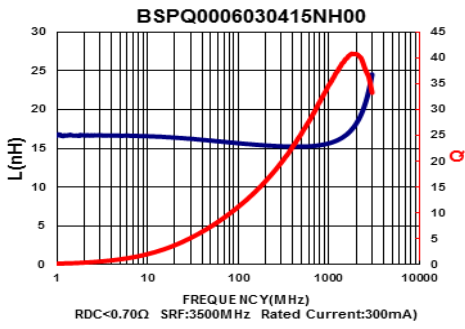

Please be sure to request approval specifications that provide further details of the products. Kindly note that the content of these specifications are subject to change or may be discontinued without prior notice. This product may not be designed/used in medical or high risk applications without ChilisIn approval. Please contact our sales department before ordering.

# SMD Ceramic High Q RF Chip Inductors – BSPQ Series

## Packaging Specifications

### Tape Dimensions

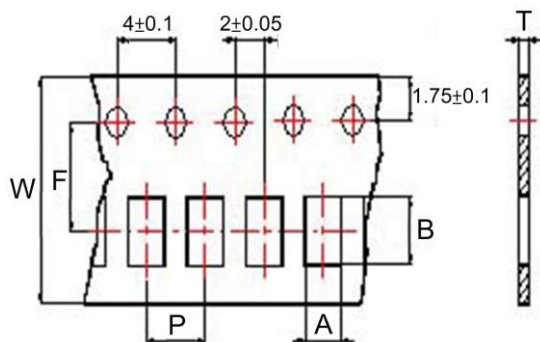

### Tape Material

Carrier tape : Paper  
Cover tape : Polyethylene

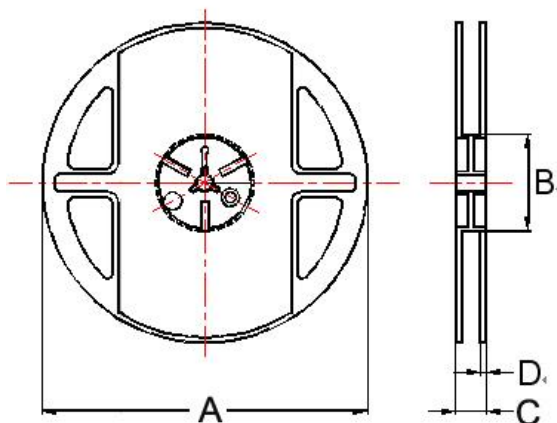
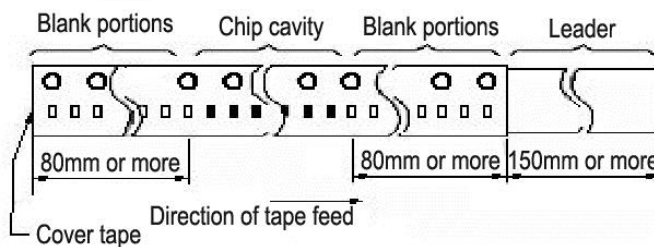

### Dimensions in mm

TYPE	Tape Dimensions						Reel Dimensions				Quantity PCS / Reel
	A	B	T	W	P	F	A	B	C	D	
BSPQ00060304	0.37	0.68	0.45	8	2	3.5	180	60	13	1.5	15000