

BMQx Series



BMQx series is low profile molding power choke with low RDC and high Q factor, so the efficiency performance is also superior. Its molded magnetic shielded type is suitable for high-density mounting and ultra-low buzz noise. Soldering conditions can be easily confirmed when mounting onto the board. This series also provides customers with embossed carrier type packaging for automatic mounting machine.

Features

- RoHS, Halogen Free and REACH Compliance
- Low RDC
- High Q
- High Efficiency
- Ultra-low buzz noise

Applications

- Laptops and PCs
- Switches and servers
- Base stations
- DC/DC converters

Product Identification

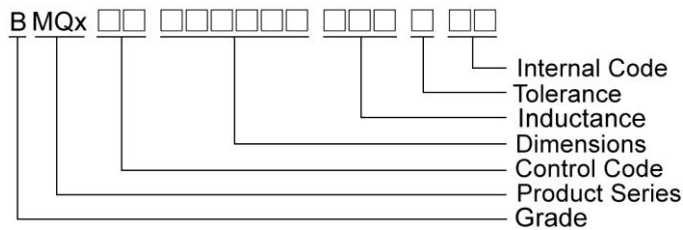

Shape and Dimensions

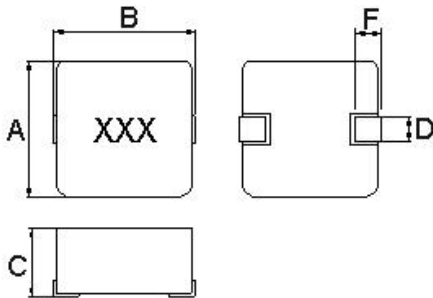

Recommended Pattern

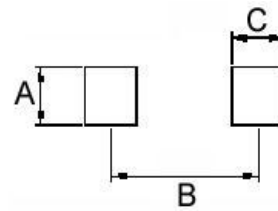

Dimensions in mm

| TYPE | A | B | C | D | F |
|--------------|----------|-----------|---------|----------|----------|
| BMQE00040410 | 4.1±0.2 | 4.6±0.2 | 1.0Max | 1.5±0.3 | 1.0±0.3 |
| BMQE00040411 | 4.1±0.2 | 4.6±0.2 | 1.1Max | 1.5±0.3 | 1.0±0.3 |
| BMQA00040420 | 4.2±0.2 | 4.8±0.2 | 1.8±0.2 | 1.5±0.3 | 1.1±0.3 |
| BMQE00050511 | 5.5±0.2 | 5.7±0.2 | 1.1Max | 2.0±0.3 | 1.5±0.3 |
| BMQA00050530 | 5.5±0.25 | 5.85±0.25 | 2.8±0.2 | 2.0±0.25 | 1.5±0.25 |
| BMQE00060611 | 6.6±0.2 | 6.95±0.35 | 1.1Max | 3.0±0.3 | 1.6±0.3 |
| BMQA00060620 | 6.8±0.2 | 6.95±0.35 | 1.8±0.2 | 3.0±0.3 | 1.6±0.3 |
| BMQA00060630 | 6.8±0.2 | 7.3±0.2 | 2.8±0.2 | 3.0±0.3 | 1.6±0.3 |
| BMQA00101040 | 10.2±0.3 | 11.3±0.3 | 3.8±0.2 | 3.0±0.5 | 2.5±0.5 |

Dimensions in mm

| TYPE | A | B | C |
|--------------|-----|------|------|
| BMQE00040410 | 2.5 | 3.7 | 1.5 |
| BMQE00040411 | 2.5 | 3.7 | 1.5 |
| BMQA00040420 | 2.5 | 3.7 | 1.5 |
| BMQE00050511 | 2.5 | 4.1 | 1.9 |
| BMQA00050530 | 2.5 | 4.6 | 1.9 |
| BMQE00060611 | 3.5 | 6.05 | 2.35 |
| BMQA00060620 | 3.5 | 6.05 | 2.35 |
| BMQA00060630 | 3.5 | 6.05 | 2.35 |
| BMQA00101040 | 4.0 | 9.50 | 3.50 |

Molding Power Inductors – BMQx Series

Electrical Characteristics

| Part Number | Inductance (uH) | Tolerance (±%) | Test Frequency (kHz) | RDC(mΩ) Max(Typ.) | Isat(A) Max(Typ.) | Irms(A) Max(Typ.) | Marking |
|-------------------|-----------------|----------------|----------------------|-------------------|-------------------|-------------------|---------|
| BMQE0004010R33MAA | 0.33 | 20 | 100 | 14(12) | 9.0(11) | 6.0(7.0) | R33 |
| BMQE00040101R0MAA | 1.0 | 20 | 100 | 43(39) | 4.0(5.0) | 4.0(4.5) | 1R0 |

Note: When ordering, please specify tolerance code. Tolerance: M=±20%

- Operating temperature range - 55°C ~ 125°C(Including self - temperature rise)
- Isat for Inductance drop 30% from its value without current
- I rms for a 40°C temperature rise from 25°C ambient with current
- Absolute maximum voltage 30VDC
- Measure Equipment :
 - L : WK 3260B or WK 6500P, 100kHz 0.5V
 - RDC : CHEN HWA 502 or CHEN HWA 46502B
 - I rms : CHROMA 1810

Test Instruments : WK3260B Impedance / Material Analyzer

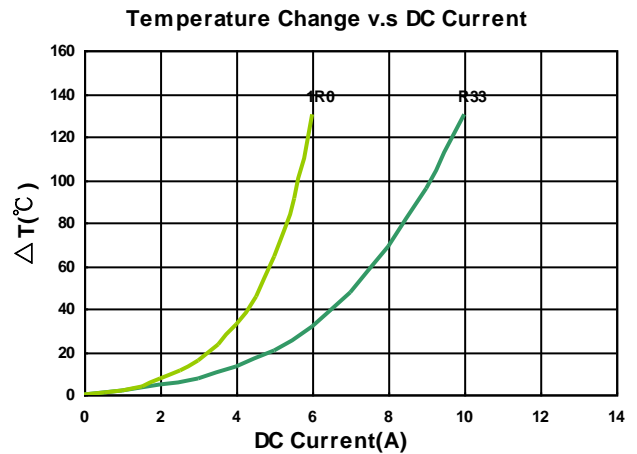
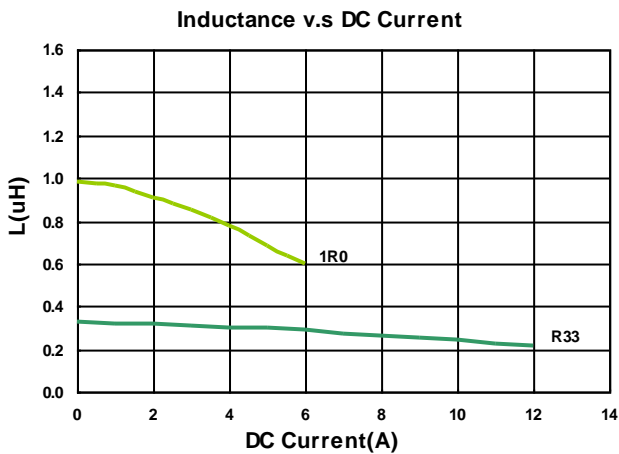

Molding Power Inductors – BMQx Series

Electrical Characteristics

| Part Number | Inductance (uH) | Tolerance (±%) | Test Frequency (kHz) | RDC(mΩ) Max(Typ.) | Isat(A) Max(Typ.) | Irms(A) Max(Typ.) | Marking |
|--------------------|-----------------|----------------|----------------------|-------------------|-------------------|-------------------|---------|
| BMQE000404111R0MAA | 1.0 | 20 | 100 | 38.5(35) | 5.4(6.0) | 4.3(4.8) | 1R0 |
| BMQE000404112R2MAA | 2.2 | 20 | 100 | 82(75) | 3.5(4.0) | 3.0(3.3) | 2R2 |

Note: When ordering, please specify tolerance code. Tolerance: M=±20%

- Operating temperature range - 55°C ~ 125°C(Including self - temperature rise)
- Isat for Inductance drop 30% from its value without current
- I rms for a 40°C temperature rise from 25°C ambient with current
- Absolute maximum voltage 30VDC
- Measure Equipment :
 L : WK 3260B or WK 6500P, 100kHz 0.5V
 RDC : CHEN HWA 502 or CHEN HWA 46502B
 I rms : CHROMA 1810

Test Instruments : WK3260B Impedance / Material Analyzer

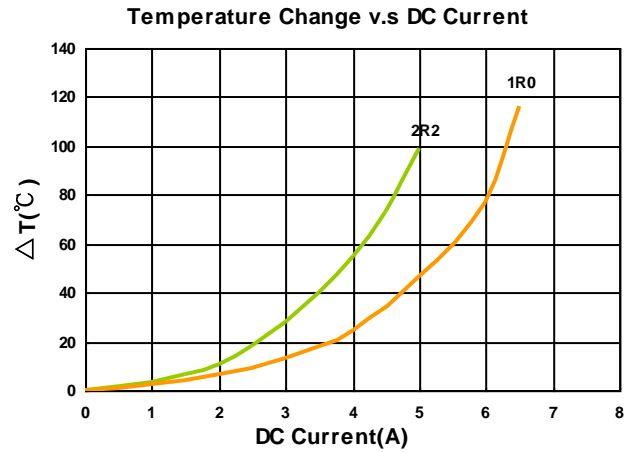
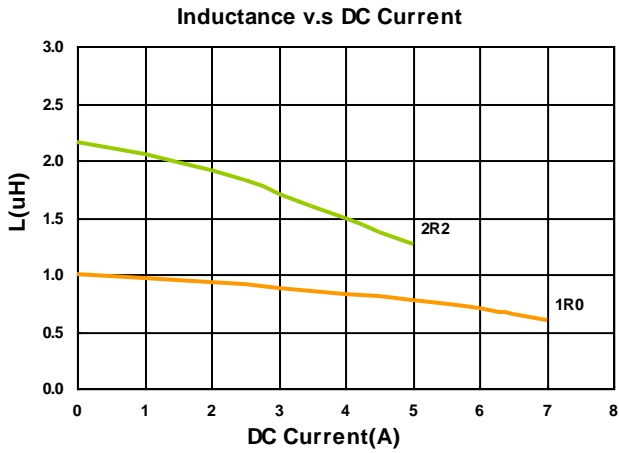

Molding Power Inductors – BMQx Series

Electrical Characteristics

| Part Number | Inductance (uH) | Tolerance (±%) | Test Frequency (kHz) | RDC(mΩ) Max(Typ.) | Isat(A) Max(Typ.) | Irms(A) Max(Typ.) | Marking |
|--------------------|-----------------|----------------|----------------------|-------------------|-------------------|-------------------|---------|
| BMQA00040420R22MA1 | 0.22 | 20 | 100 | 5.5(5.0) | 18(20) | 10(11) | R22 |
| BMQA000404201R0MA1 | 1.0 | 20 | 100 | 17(16) | 8.0(8.5) | 5.5(6.0) | 1R0 |
| BMQA000404202R2MA1 | 2.2 | 20 | 100 | 38.5(35) | 6.0(6.5) | 4.0(4.5) | 2R2 |
| BMQA000404204R7MA1 | 4.7 | 20 | 100 | 85(77) | 4.0(4.5) | 2.5(2.8) | 4R7 |

Note: When ordering, please specify tolerance code. Tolerance: M=±20%

- Operating temperature range - 55°C ~ 125°C(Including self - temperature rise)
- Isat for Inductance drop 30% from its value without current
- I rms for a 40°C temperature rise from 25°C ambient with current
- Absolute maximum voltage 30VDC
- Measure Equipment :
 L : WK 3260B or WK 6500P, 100kHz 0.5V
 RDC : CHEN HWA 502 or CHEN HWA 46502B
 I rms : CHROMA 1810

Test Instruments : WK3260B Impedance / Material Analyzer

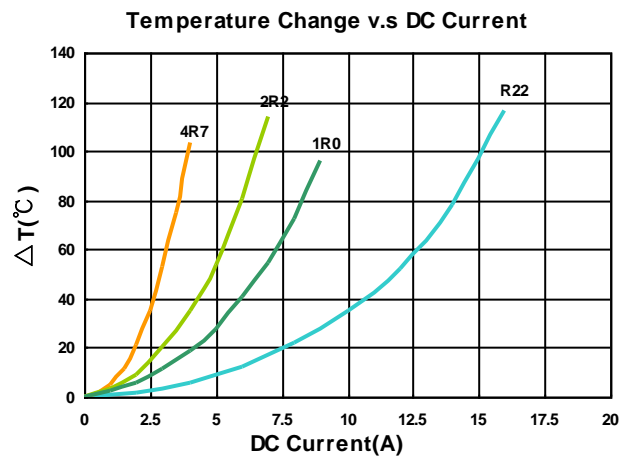
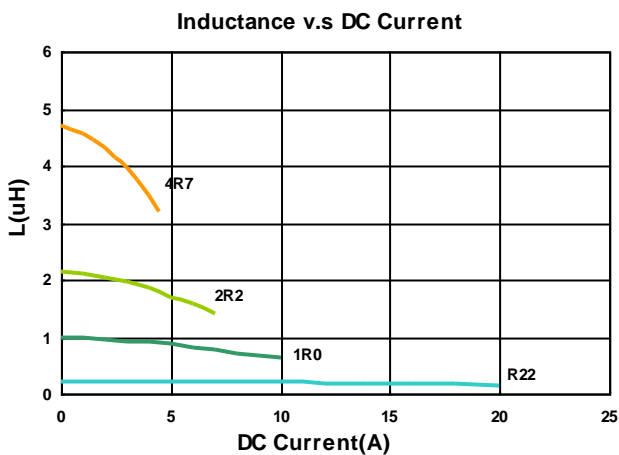

Molding Power Inductors – BMQx Series

Electrical Characteristics

| Part Number | Inductance (uH) | Tolerance (±%) | Test Frequency (kHz) | RDC(mΩ) Max(Typ.) | Isat(A) Max(Typ.) | Irms(A) Max(Typ.) | Marking |
|--------------------|-----------------|----------------|----------------------|-------------------|-------------------|-------------------|---------|
| BMQE000505111R0MAA | 1.0 | 20 | 100 | 33(30) | 7.0(7.5) | 4.8(5.3) | 1R0 |

Note: When ordering, please specify tolerance code. Tolerance: M=±20%

- Operating temperature range - 55°C ~ 125°C(Including self - temperature rise)
- Isat for Inductance drop 30% from its value without current
- I rms for a 40°C temperature rise from 25°C ambient with current
- Absolute maximum voltage 30VDC
- Measure Equipment :
 L : WK 3260B or WK 6500P, 100kHz 0.5V
 RDC : CHEN HWA 502 or CHEN HWA 46502B
 I rms : CHROMA 1810

Test Instruments : WK3260B Impedance / Material Analyzer

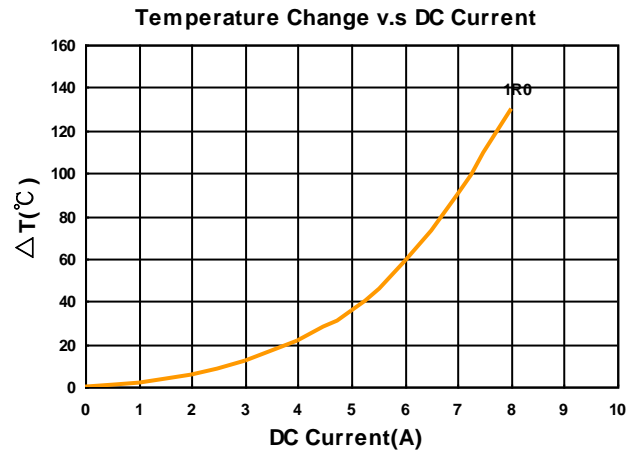
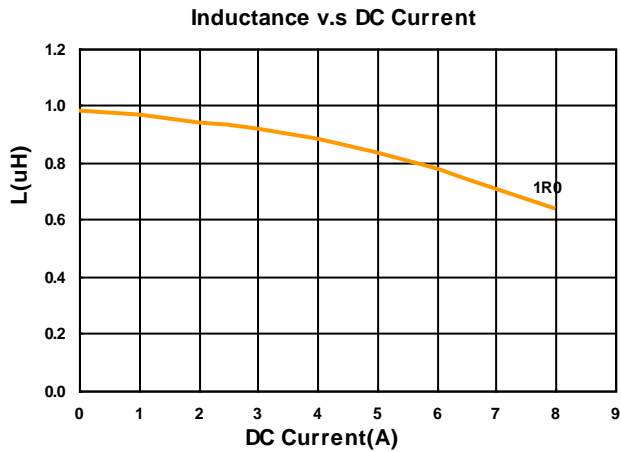

Molding Power Inductors – BMQx Series

Electrical Characteristics

| Part Number | Inductance (uH) | Tolerance (±%) | Test Frequency (kHz) | RDC(mΩ) Max(Typ.) | Isat(A) Max(Typ.) | Irms(A) Max(Typ.) | Marking |
|--------------------|-----------------|----------------|----------------------|----------------------|----------------------|----------------------|---------|
| BMQA00050530R22MA1 | 0.22 | 20 | 100 | 3.90(3.5) | 28(32) | 18.0(20.0) | R22 |
| BMQA00050530R36MA1 | 0.36 | 20 | 100 | 4.95(4.5) | 23(25) | 12.5(13.5) | R36 |
| BMQA00050530R68MA1 | 0.68 | 20 | 100 | 6.30(5.7) | 17(18) | 11.0(12.0) | R68 |
| BMQA000505301R0MA1 | 1.0 | 20 | 100 | 9.8(8.9) | 16(18) | 9.00(9.50) | 1R0 |
| BMQA000505301R5MA1 | 1.5 | 20 | 100 | 15(13.5) | 12.5(13.5) | 7.50(8.0) | 1R5 |
| BMQA000505302R2MA1 | 2.2 | 20 | 100 | 20(18) | 11.5(12.5) | 6.00(6.5) | 2R2 |
| BMQA000505304R7MA1 | 4.7 | 20 | 100 | 40(37) | 6.5(7.50) | 4.50(5.0) | 4R7 |

Note: When ordering, please specify tolerance code. Tolerance: M=±20%

- Operating temperature range - 55°C ~ 125°C(Including self - temperature rise)
- Isat for Inductance drop 30% from its value without current
- I rms for a 40°C temperature rise from 25°C ambient with current
- Absolute maximum voltage 30VDC
- Measure Equipment :
 L : WK 3260B or WK 6500P, 100kHz 0.5V
 RDC : CHEN HWA 502 or CHEN HWA 46502B
 I rms : CHROMA 1810

Test Instruments : WK3260B Impedance / Material Analyzer

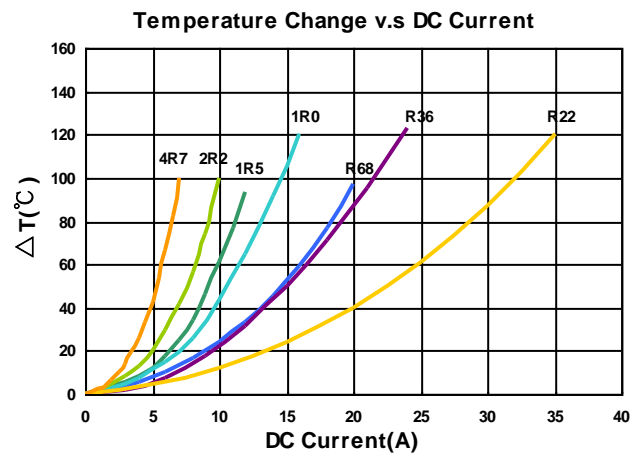
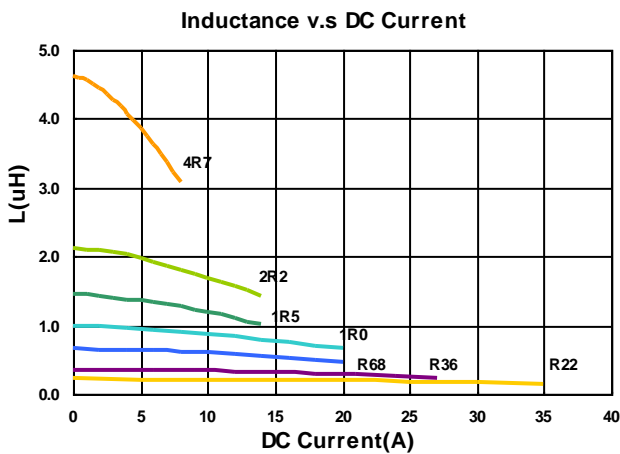

Molding Power Inductors – BMQx Series

Electrical Characteristics

| Part Number | Inductance (uH) | Tolerance (±%) | Test Frequency (kHz) | RDC(mΩ) Max(Typ.) | Isat(A) Max(Typ.) | Irms(A) Max(Typ.) | Marking |
|--------------------|-----------------|----------------|----------------------|-------------------|-------------------|-------------------|---------|
| BMQE000606111R0MAA | 1.0 | 20 | 100 | 26(24.5) | 7.0(7.8) | 6.8(7.3) | 1R0 |
| BMQE000606112R2MAA | 2.2 | 20 | 100 | 57(52) | 5.0(6.0) | 4.2(4.6) | 2R2 |

Note: When ordering, please specify tolerance code. Tolerance: M=±20%

- Operating temperature range - 55°C ~ 125°C(Including self - temperature rise)
- Isat for Inductance drop 30% from its value without current
- I rms for a 40°C temperature rise from 25°C ambient with current
- Absolute maximum voltage 30VDC
- Measure Equipment :
 L : WK 3260B or WK 6500P, 100kHz 0.5V
 RDC : CHEN HWA 502 or CHEN HWA 46502B
 I rms : CHROMA 1810

Test Instruments : WK3260B Impedance / Material Analyzer

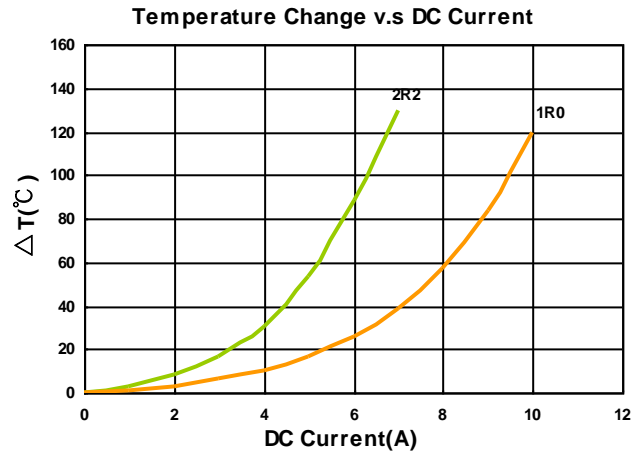
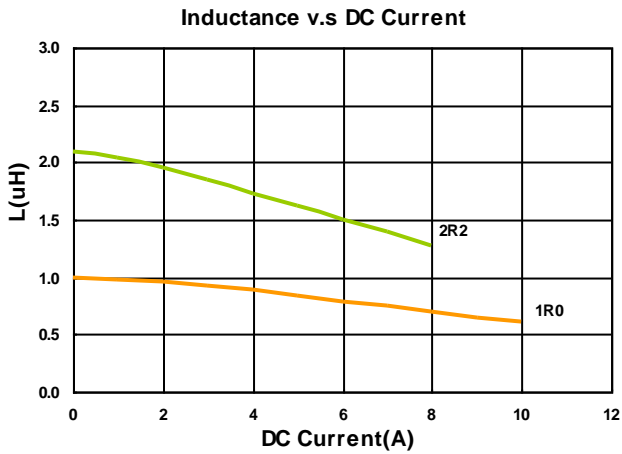

Molding Power Inductors – BMQx Series

Electrical Characteristics

| Part Number | Inductance (uH) | Tolerance (±%) | Test Frequency (kHz) | RDC(mΩ) Max(Typ.) | Isat(A) Max(Typ.) | Irms(A) Max(Typ.) | Marking |
|--------------------|-----------------|----------------|----------------------|-------------------|-------------------|-------------------|---------|
| BMQA000606204R7MA1 | 4.7 | 20 | 100 | 48(43.7) | 6.0(6.8) | 4.2(4.7) | 4R7 |

Note: When ordering, please specify tolerance code. Tolerance: M=±20%

- Operating temperature range - 55°C ~ 125°C(Including self - temperature rise)
- Isat for Inductance drop 30% from its value without current
- I rms for a 40°C temperature rise from 25°C ambient with current
- Absolute maximum voltage 30VDC
- Measure Equipment :
 L : WK 3260B or WK 6500P, 100kHz 0.5V
 RDC : CHEN HWA 502 or CHEN HWA 46502B
 I rms : CHROMA 1810

Test Instruments : WK3260B Impedance / Material Analyzer

Inductance v.s DC Current

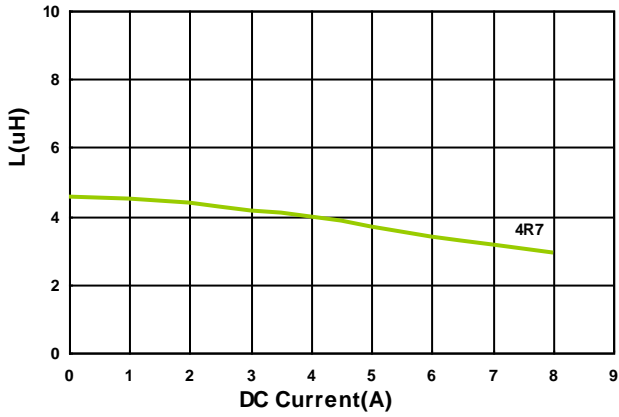

Temperature Change v.s DC Current

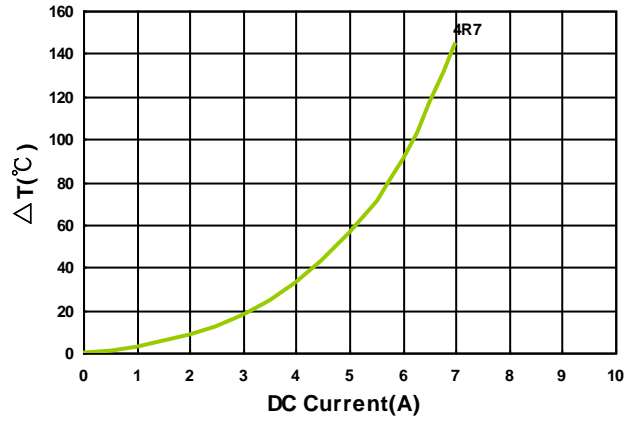

Molding Power Inductors – BMQx Series

Electrical Characteristics

| Part Number | Inductance (uH) | Tolerance (±%) | Test Frequency (kHz) | RDC(mΩ) Max(Typ.) | Isat(A) Max(Typ.) | Irms(A) Max(Typ.) | Marking |
|---------------------|-----------------|----------------|----------------------|-------------------|-------------------|-------------------|---------|
| BMQA00060630R22MA1 | 0.22 | 20 | 100 | 2.0(1.8) | 35(40) | 25(27) | R22 |
| BMQA00060630R36MA1 | 0.36 | 20 | 100 | 2.6(2.3) | 27(32) | 23(25) | R36 |
| BMQA00060630R47MA1 | 0.47 | 20 | 100 | 3.3(2.9) | 25(27) | 19(20) | R47 |
| BMQA00060630R56MA1 | 0.56 | 20 | 100 | 3.9(3.5) | 23(25) | 17(18) | R56 |
| BMQA00060630R68MA1 | 0.68 | 20 | 100 | 4.2(3.8) | 18(20) | 16(17) | R68 |
| BMQA00060630R1R0MA1 | 1.0 | 20 | 100 | 5.3(4.8) | 17(19) | 14(15) | 1R0 |
| BMQA00060630R1R5MA1 | 1.5 | 20 | 100 | 7.7(7.0) | 15(17) | 11(11.5) | 1R5 |
| BMQA00060630R2R2MA1 | 2.2 | 20 | 100 | 9.4(8.5) | 12(12.5) | 10.5(11) | 2R2 |
| BMQA00060630R3R3MA1 | 3.3 | 20 | 100 | 15(13.5) | 9.0(9.5) | 8.0(8.5) | 3R3 |
| BMQA00060630R4R7MA1 | 4.7 | 20 | 100 | 22.0(20) | 6.5(7.0) | 6.0(6.5) | 4R7 |
| BMQA00060630R6R8MA1 | 6.8 | 20 | 100 | 38.5(35) | 6.0(6.5) | 5.3(5.8) | 6R8 |
| BMQA00060630R8R2MA1 | 8.2 | 20 | 100 | 47.0(43) | 5.5(6.0) | 5.0(5.4) | 8R2 |
| BMQA00060630R100MA1 | 10 | 20 | 100 | 47.0(43) | 5.0(5.5) | 4.8(5.3) | 100 |

Note: When ordering, please specify tolerance code. Tolerance: M=±20%

- Operating temperature range - 55°C ~ 125°C(Including self - temperature rise)
- Isat for Inductance drop 30% from its value without current
- Irms for a 40°C temperature rise from 25°C ambient with current
- Absolute maximum voltage 30VDC
- Measure Equipment :
 L : WK 3260B or WK 6500P, 100kHz 0.5V
 RDC : CHEN HWA 502 or CHEN HWA 46502B
 Irms : CHROMA 1810

Test Instruments : WK3260B Impedance / Material Analyzer

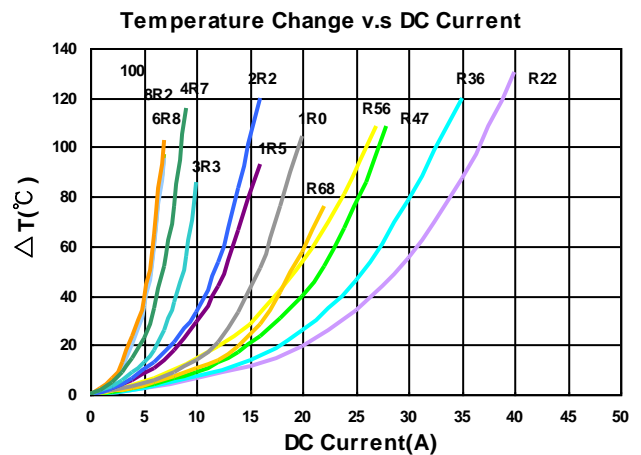
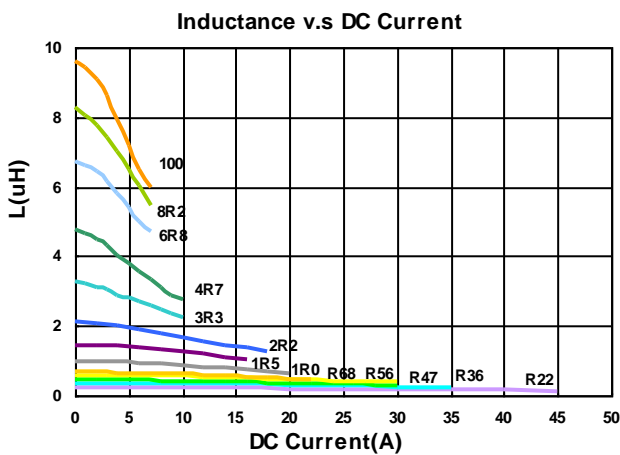

Molding Power Inductors – BMQx Series

Electrical Characteristics

| Part Number | Inductance (uH) | Tolerance (±%) | Test Frequency (kHz) | RDC(mΩ) Max(Typ.) | Isat(A) Max(Typ.) | Irms(A) Max(Typ.) | Marking |
|--------------------|-----------------|----------------|----------------------|-------------------|-------------------|-------------------|---------|
| BMQA00101040R22MD1 | 0.22 | 20 | 100 | 0.54(0.45) | 55(60) | 40(42) | R22 |
| BMQA00101040R33MD1 | 0.33 | 20 | 100 | 0.68(0.62) | 45(50) | 32(35) | R33 |
| BMQA00101040R68MD1 | 0.68 | 20 | 100 | 1.5(1.3) | 32(37) | 25(27) | R68 |
| BMQA001010401R0MD1 | 1.0 | 20 | 100 | 2.4(2.2) | 26(30) | 23(25) | 1R0 |
| BMQA001010402R2MA1 | 2.2 | 20 | 100 | 4.7(4.3) | 17(20) | 15(15.6) | 2R2 |
| BMQA001010403R3MA1 | 3.3 | 20 | 100 | 7.9(7.2) | 16(18) | 12(12.5) | 3R3 |
| BMQA001010404R7MA1 | 4.7 | 20 | 100 | 10.5(9.5) | 13(14) | 10.5(11) | 4R7 |
| BMQA001010406R8MA1 | 6.8 | 20 | 100 | 16.5(15) | 9.0(10) | 8.5(9.0) | 6R8 |
| BMQA00101040100MA1 | 10 | 20 | 100 | 24(22) | 8.5(9.0) | 8.0(8.5) | 100 |

Note: When ordering, please specify tolerance code. Tolerance: M=±20%

- Operating temperature range - 55°C ~ 125°C(Including self - temperature rise)
- Isat for Inductance drop 30% from its value without current
- I rms for a 40°C temperature rise from 25°C ambient with current
- Absolute maximum voltage 30VDC
- Measure Equipment :
 L : WK 3260B or WK 6500P, 100kHz 0.5V
 RDC : CHEN HWA 502 or CHEN HWA 46502B
 I rms : CHROMA 1810

Test Instruments : WK3260B Impedance / Material Analyzer

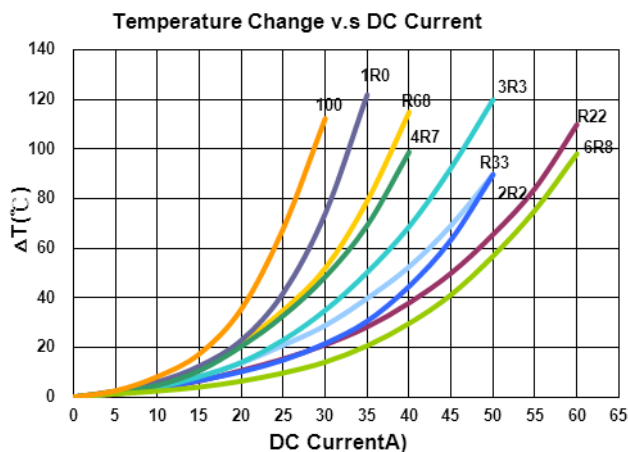
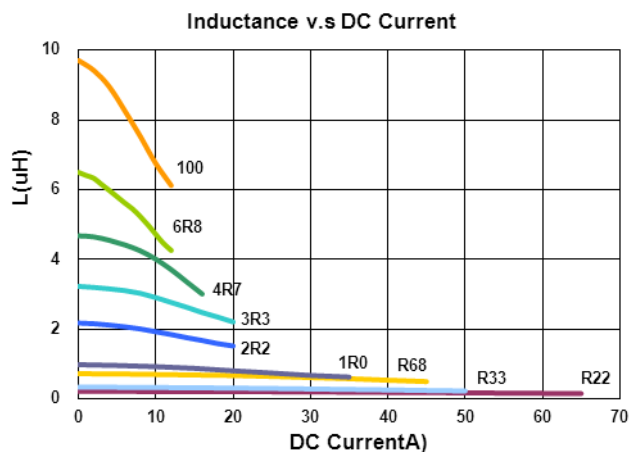

Packaging Specifications

Tape Dimensions

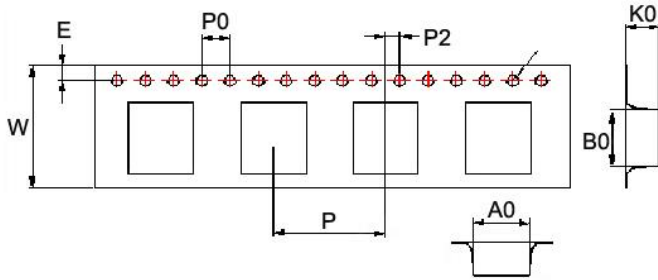

Tape Material

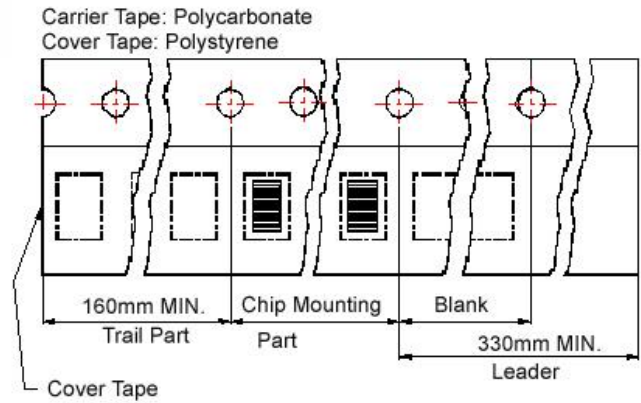

Reel Dimensions

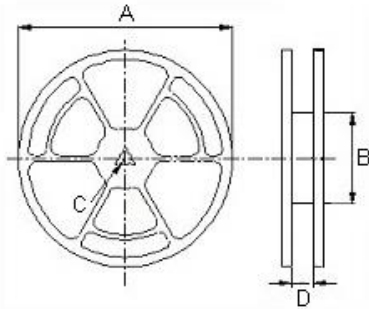

Dimensions in mm

| TYPE | Tape Dimensions | | | | | | | | | Reel Dimensions | | | | Quantity PCS / REEL |
|--------------|-----------------|------|------|------|------|----|----|----|----|-----------------|-----|----|------|------------------------|
| | A0 | B0 | K0 | D | E | W | P | P0 | P2 | A | B | C | D | |
| BMQE00040410 | 4.4 | 4.9 | 1.4 | 1.55 | 1.75 | 12 | 8 | 4 | 2 | 330 | 100 | 13 | 13.4 | 2000 |
| BMQE00040411 | 4.4 | 4.9 | 1.5 | 1.55 | 1.75 | 12 | 8 | 4 | 2 | 330 | 100 | 13 | 13.4 | 2000 |
| BMQA00040420 | 4.5 | 5.1 | 2.4 | 1.55 | 1.75 | 12 | 8 | 4 | 2 | 330 | 100 | 13 | 13.4 | 2000 |
| BMQE00050511 | 5.9 | 6.2 | 1.5 | 1.55 | 1.75 | 16 | 12 | 4 | 2 | 330 | 100 | 13 | 16 | 2000 |
| BMQA00050530 | 5.9 | 6.25 | 3.4 | 1.55 | 1.75 | 16 | 12 | 4 | 2 | 330 | 100 | 13 | 16 | 1000 |
| BMQE00060611 | 6.9 | 7.4 | 1.5 | 1.55 | 1.75 | 16 | 12 | 4 | 2 | 330 | 100 | 13 | 16 | 1000 |
| BMQA00060620 | 7.05 | 7.6 | 2.7 | 1.55 | 1.75 | 16 | 12 | 4 | 2 | 330 | 100 | 13 | 16 | 1000 |
| BMQA00060630 | 7.0 | 7.6 | 3.4 | 1.55 | 1.75 | 16 | 12 | 4 | 2 | 330 | 100 | 13 | 16 | 1000 |
| BMQA00101040 | 10.6 | 11.7 | 4.25 | 1.55 | 1.75 | 24 | 16 | 4 | 2 | 330 | 100 | 13 | 24.4 | 500 |